



HOW TO BUY ORNAMENTAL STEEL FENCE

1 - PLANNING CHECKLIST

1-1 REVIEW LOCAL REGULATIONS

Check with appropriate jurisdictions (e.g. state, local, subdivision, etc.) for:

- Mandatory Setbacks _____
- Permissible Heights _____
- Style Limitations _____
- Permit Required? Yes No
- Special Pool Fence Requirements _____

1-2 LOCATE UNDERGROUND UTILITIES

Contact local utility companies to flag all buried cables or pipelines, etc.

- Water Gas Phone Electric Cable TV _____

1-3 DETERMINE LEGAL BOUNDARIES

Because fence footings must not extend beyond your legally established property line, you will need to know the exact location of that line to be able to mark it prior to installation. If you are uncertain, refer to the real estate plot plan or consult a professional surveyor.

1-4 SELECT FENCE STYLE & HEIGHT

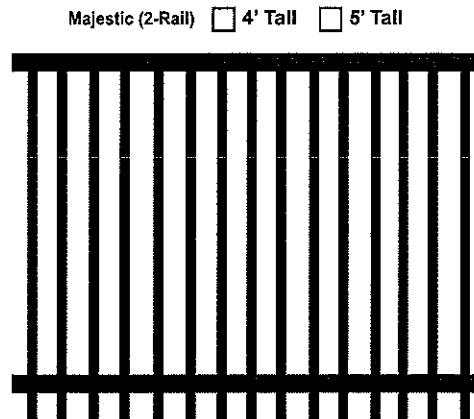
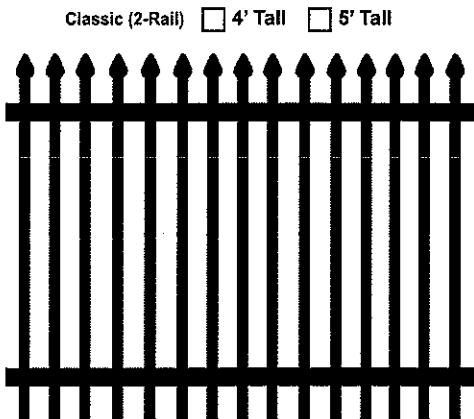

1-5 GATHER NECESSARY TOOLS

- | | | | |
|--|--|---|--------------------------------------|
| <input type="checkbox"/> String Line | <input type="checkbox"/> Carpenter's Level | <input type="checkbox"/> Round Blade Shovel | <input type="checkbox"/> Power Drill |
| <input type="checkbox"/> Stakes | <input type="checkbox"/> Eye Protection/Gloves | <input type="checkbox"/> Wheelbarrow | <input type="checkbox"/> _____ |
| <input type="checkbox"/> Measuring Tape | <input type="checkbox"/> Pocket Calculator | <input type="checkbox"/> Crescent Wrench | <input type="checkbox"/> _____ |
| <input type="checkbox"/> Red Grease Pencil | <input type="checkbox"/> Post Hole Digger | <input type="checkbox"/> Hacksaw | <input type="checkbox"/> _____ |

2 - MATERIALS WORKSHEET

2-1 SKETCH FENCE PLAN

After reviewing the Material List and Example, sketch your fence plan and dimension the fence lines & gates on the Site Plan grid below.

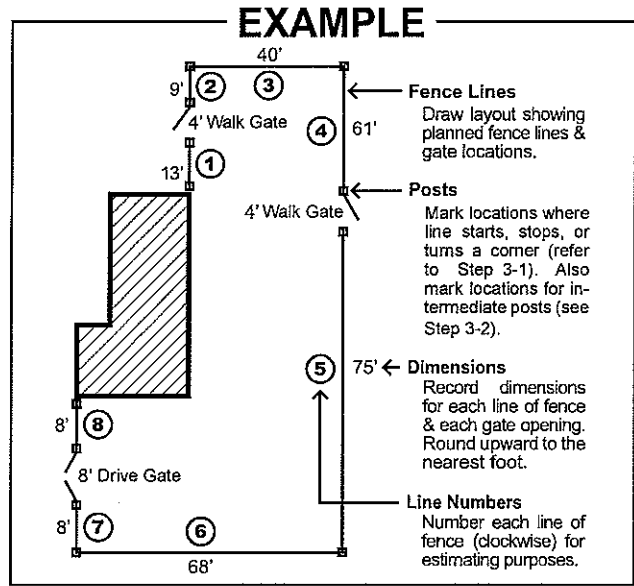
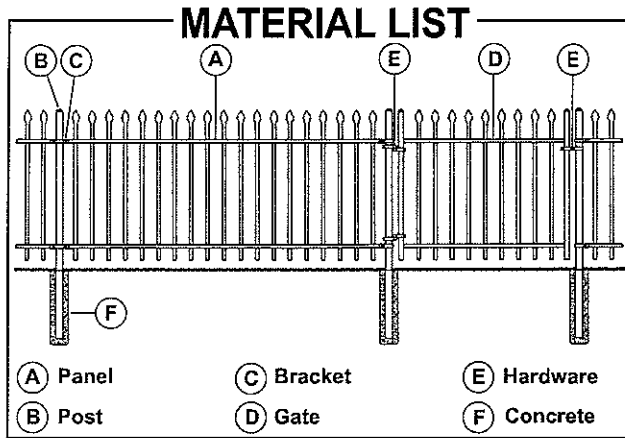

SITE PLAN

2-2 ESTIMATE QUANTITIES NEEDED

PANEL CALCULATION

(*Note: Round panel quantities up to nearest whole number.)

Line Number	Length (in Feet)	Panel Quantity* (Per Line)
EXAMPLE Fence Line 1 Above:	13	13 ÷ 8 = 2
①		÷ 8 =
②		÷ 8 =
③		÷ 8 =
④		÷ 8 =
⑤		÷ 8 =
⑥		÷ 8 =
⑦		÷ 8 =
⑧		÷ 8 =
⑨		÷ 8 =
⑩		÷ 8 =
TOTAL		

ITEM	ESTIMATING ACTIVITY	TOTALS
PANELS	Copy Total From Panel Calculation Above	
POSTS	Add Total Number of Panels + Total Number of Gates + 1	
BRACKET KITS (2 Brackets Per Kit)	Multiply Total Number of Panels By 2	
SINGLE GATES	<input type="checkbox"/> For 4' Tall Fence	
	<input type="checkbox"/> For 5' Tall Fence	
DOUBLE GATES	<input type="checkbox"/> For 4' Tall Fence	
	<input type="checkbox"/> For 5' Tall Fence	
HARDWARE KITS (for Single Gates)	Add Number of Single Gates	
HARDWARE KITS (for Double Gates)	Add Number of Double Gates	
CONCRETE MIX (In 80 Lb. Bags)	Figure 1 Bag Per 2 Posts	
ZINC PRIMER	Figure 1 Can for Every 24 Panels	
TOUCH-UP	Figure 1 Can for Every 12 Panels	

3 - INSTALLATION INSTRUCTIONS

3-1 MARK LOCATIONS FOR ENDS, CORNERS & GATES

Using a string line, mark your property's boundary lines. Based on your worksheet site plan, locate each point where the fence starts, stops or turns a corner (including points for gate locations) and mark it with a stake (Figure 3-1).

Note: Unless you have prior agreement from your neighbor(s) to share the fence, it is recommended that all posts be set approximately 4" inside the property line so that concrete footings do not encroach onto any adjoining property.

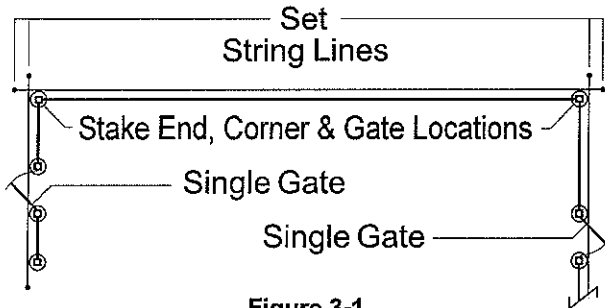

Figure 3-1

When staking gate post locations, space the opening between posts (inside post face to inside post face) according to the following table:

SINGLE GATE	4' Nominal	48-1/2"
DOUBLE GATE	8' Nominal	95"

3-2 MARK ALL REMAINING POST LOCATIONS

Starting at an end point, run a tape measure along the ground to the next stopping point, and drive intermediate stakes at equal intervals of 96³/₄", plus or minus 1/2", to mark the locations for your remaining posts.

Note: All measurements must be made along the ground elevation, regardless of slope. This ensures the ATF (All Terrain Fence) feature is properly employed when panels are 'raked' to follow grade (see Step 3-4).

If you are left with a space that is less than 96³/₄", a full panel can be cut to make a partial panel that fits the final interval (see Step 3-5). Repeat the same procedure for each separate line of fence.

Note: If any line of fence ends up with a partial panel that is less than four feet long, you may wish to use the following method to 'balance' that line:

Measure the distance between each end of the line; drive a stake halfway between the ends. Proceed from the center stake to the left end, staking every 96³/₄"; then return to center and repeat the process as you move toward the right end (Figure 3-2).

Example of 'Balancing' a Line of Fence

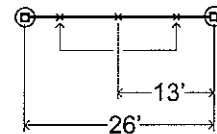

Figure 3-2

The example of Figure 3-2 results in equal partial panels approximately 5' long at either end; rather than 3 full panels and a segment less than 2' long.

3-3 SET POSTS

Dig post holes at each marking stake (see Figure 3-3). The exact diameter and depth of the hole may need to be increased depending on local weather and soil conditions. Regardless of depth of the hole, post height (from ground line) should always be set as follows:

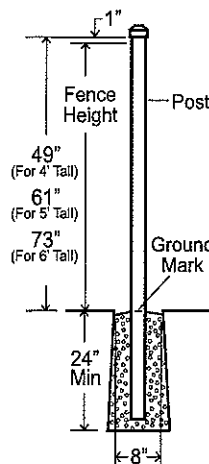

Figure 3-3

On each post, starting from the bottom of the overlapping post cap, measure a length equal to the fence height plus 1" (see Figure 3-3) and, using a grease pencil, mark that point to indicate the ground line.

Center the posts in the holes. Surround each post with concrete in a continuous pour. Before the concrete sets, make sure that post is located properly, plumb, and at the correct height (based on ground level mark). Trowel finish around posts, sloping downward to direct water away.

3-4 MOUNT FULL PANELS

When the post footings have become sufficiently rigid to stabilize the posts, slip the universal brackets over the posts according to one of the three configurations shown in Figure 3-4a, whichever is applicable.

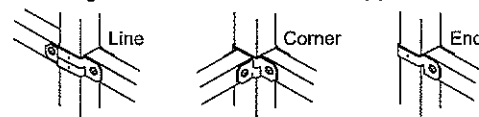

Figure 3-4a

Line and corner posts will require four (4) universal brackets; End posts will require two universal brackets.

3 - INSTALLATION INSTRUCTIONS

Mount panels as shown in Fig. 3-4b. Unless the tops of the posts are level, always begin with the higher post first. Insert rail ends into brackets, hand-tighten hex nuts onto carriage bolts, and fine-tune to ensure panel is positioned at proper height.

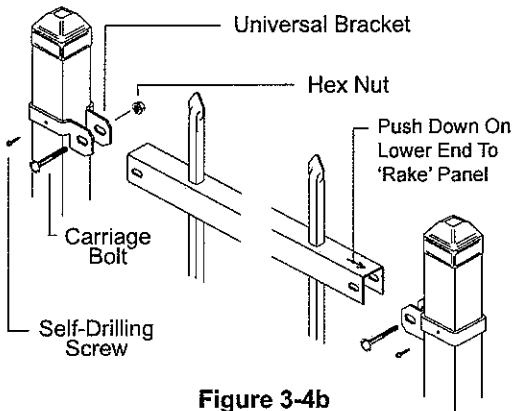

Figure 3-4b

Bottom-most part of panel should be 2" higher than the ground level mark on the post. Using a wrench, tighten hex nuts to hold rails rigidly in place. Fix brackets in place with hex-headed self-drilling screws. On the opposite end of the panel, position the rails so that the bottom-most part of the panel is 2" above ground. *Note: Whenever the second post is lower than the first, it will be necessary to 'rake' the panel by pushing the unfastened end downward until it is positioned at the appropriate height.* Attach and tighten the brackets on the second post to complete panel installation.

3-5 TRIM & MOUNT PARTIAL PANELS

For remaining spaces that are too narrow for mounting a full panel, measure the distance between posts, inside post face to inside post face. Subtract 1/2" and the remainder is the length to cut the partial panel. Using the metal-cutting hacksaw, trim partial panels as shown in Figure 3-5. Make sure that rails extend equally from last picket at both ends of panel.

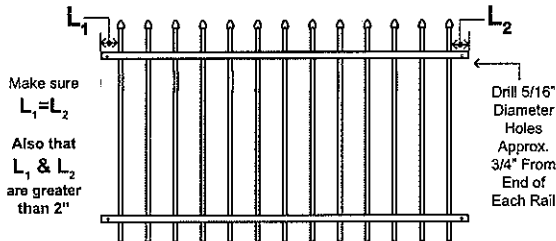

Figure 3-5

Drill holes as shown in Figure 3-5; then clean the cut and drilled surfaces to remove burrs along with any metal residue. Following the paint manufacturer's instructions, first apply a coat of zinc-rich primer, then, after allowing sufficient time for primer to dry, finish with the spray application of color-matching topcoat. When finish coat is dry, mount partial panels using the procedure in Step 3-4.

3-6 MOUNT GATES

All gates come welded and ready to install; no assembly is required. The procedure described here covers installation with standard bolt-on gate hardware (if self-closing hardware is required, install in accordance with the instructions supplied with the hardware kit.). Figure 3-6 shows a typical single swing gate installation.

Attach pin hinges approximately 8" from the top and bottom of the gate post, with top hinge pin pointing down and bottom hinge pin pointing up. It may be necessary to adjust locations slightly to avoid interference from horizontal rails. Tighten bolts securely.

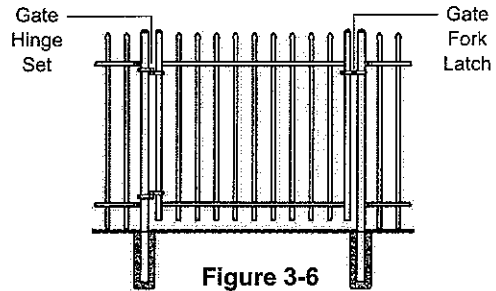

Figure 3-6

Loosely fasten frame hinges to gate frame. Hang gate in place, allowing approximately 2" of ground clearance. Slide frame hinges to fit snugly over pin hinges, then tighten securely. The same method applies to double gates with the added step of fixing one leaf with a drop rod.

MONTAGE IS THE EASIEST TO INSTALL

- NO ASSEMBLY REQUIRED
- NO WELDING REQUIRED
- NO HASTLE WITH GATES



Manufactured by Ameristar Fence Products, Inc. • Tulsa, OK